

252 Series Parallel Arms

OVERVIEW

With hundreds of systems installed in the most demanding environments our parallel arm lifters are a robust, well proven manipulator for high performance ergonomic handling of a wide variety of loads.

- Capacity from 5kg to 150kg
- Working height range up to 1500mm
- Reach up to 2500mm, with up to 360° slewing
- A large range of standard accessories
- A range of configurations from floor standing to overhead crane mounting
- Fully pneumatic with powered or balanced lifting

Andron parallel arms are ideal for the manipulation of components needing orientation changes during lifting, or where there are obstructions that prevent traditional cranes systems from being used.

Heavily utilised in the automotive industry on main vehicle assembly and sub assembly production lines our systems are trusted to work reliably for hundreds of thousands of cycles annually giving a long service life with low maintenance levels



UP TO
150
KG

UP TO
1.5m
LIFT

UP TO
2.5m
REACH

Floor standing parallel arm on mobile forklift base with optional secondary reach arm

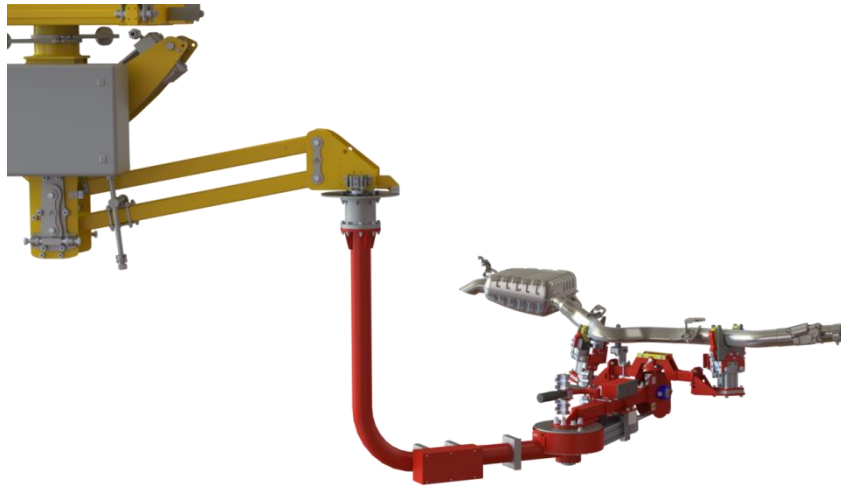

Overhead rail mounted parallel arm for exhaust system assembly in automotive production lines



Fixed floor standing parallel arm for hot press loading in aerospace component manufacture



Overhead rail mounted parallel arm for paint bar removal on an automotive production line



Overhead rail mounted parallel arm for battery handling

CAPACITY

Note that there are a number of options we can adjust to modify the lift capacity, reach and working height range to suit your application. Our engineers will carry out detailed calculations to specify the correct system for your application.

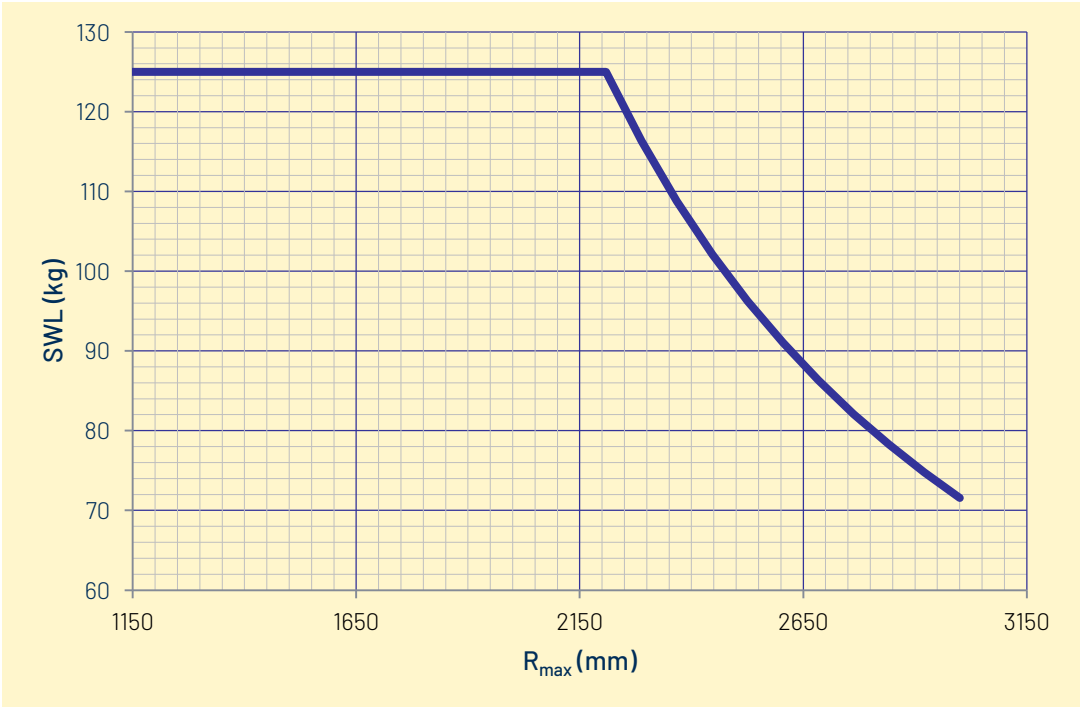
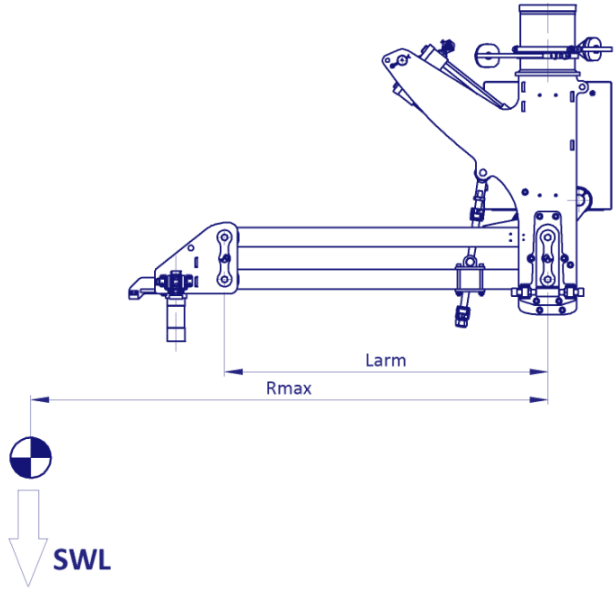



Fixed Floor Standing



Mobile Floor Standing



Overhead Rail Mount



Light Crane Systems

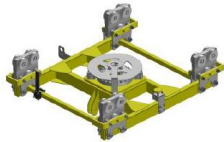

Carriages



Floor Posts

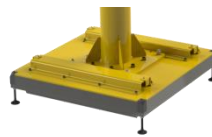

Mobile Base Units



Secondary Arms & Drop Arms

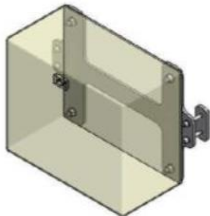

Pneumatic Cabinet Accessories

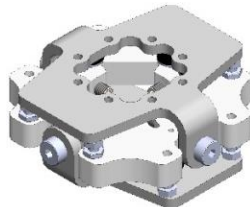

Gimbal Kits

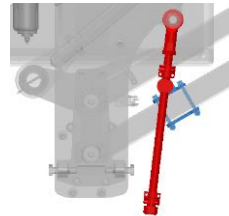

Height Stops



Indexing Height Stops

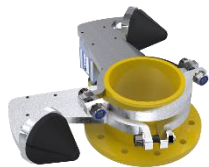

Adjustable Rotation Stops

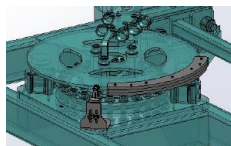

Rotation Angle Sensors

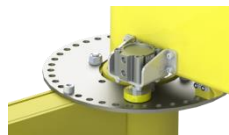

Parking Brake Kits

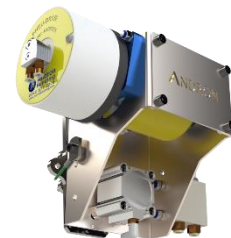

Pneumatic Travel Drives